

SENSOFAR[®]
METROLOGY



Engineered for Speed
QA/QC and R&D Solution

S **neox**
3D Optical Profiler

Simply powerful

The new S neox outperforms existing optical 3D profiling microscopes in terms of performance, functionality, efficiency and design providing Sensofar with a class-leading areal measurement system.

Easy-to-use

Sensofar is continuously working to provide the most incredible experience to our customers. With the fifth generation of the S neox systems, the goal has been to make it easy to use, intuitive and faster. Even if you are beginner user, the system can be managed with just one click. Software modules have been created to adapt the system to the user requirements.

Faster than ever

Everything is faster than before with new smart and unique algorithms and a new camera. Data acquisition is taken at 180 fps. Standard measurement acquisition is 5X faster than before. Making the S neox the fastest areal measurement system in the market.



Markets and applications

- Aerospace & Automotive
- Energy
- Forensics
- Medical Devices
- Microelectronics
- Micromanufacturing
- Semiconductors
- Surface Finish
- Tooling Industry
- Optics
- Watch Manufacturing

Versatile

Quality control

Automated modules have been created to facilitate all QC procedures. Ranging from operator access rights control, recipes, compatibility to barcode/QR readers, and customized plugins from our proprietary SensoPRO software to generate pass/fail reports. Our optimized solutions are able to work in QC environments due to their flexibility and easy-to-use interface, which can be programmed to work 24/7.

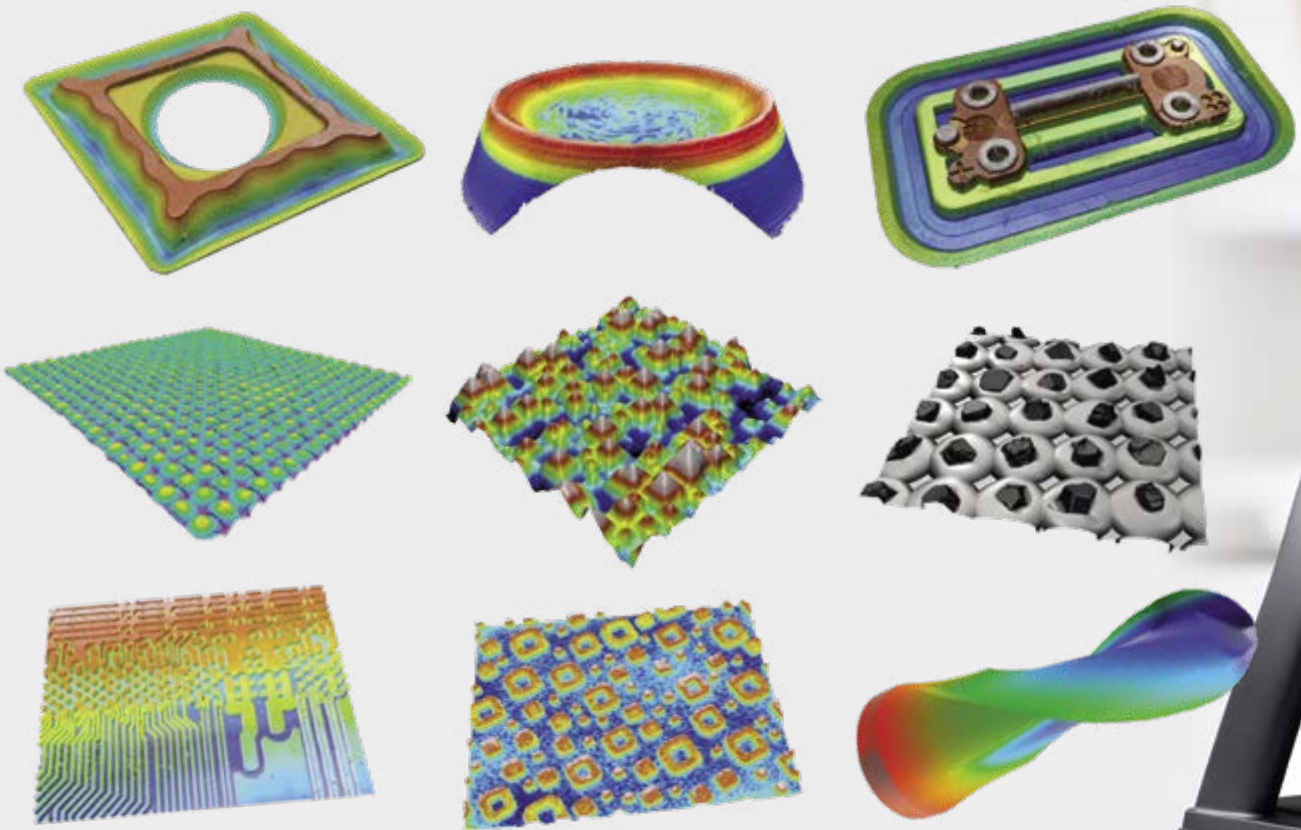

Traceability

Every S neox is manufactured to deliver accurate and traceable measurements. Systems are calibrated using traceable standards following the ISO 25178 standard for: Z amplification factor, XY lateral dimensions, flatness error, as well as parcentricity and parfocality.

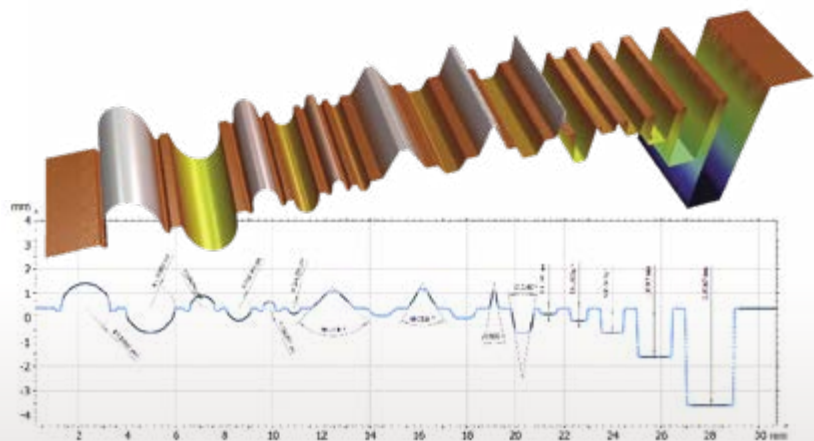

system

Research & Development

With Sensofar's 3-in-1 approach –a single click in SensoSCAN switches the system to the best technique for the task at hand. The three measurement techniques found in the S neox sensor head –Confocal, Interferometry, Ai Focus Variation– each contribute critically to the versatility of the system and help to minimize undesirable compromises in the data acquisition. The S neox is ideal for all lab environments, without limitations.



Surface parameters are calculated according to ISO25178 and ISO4278. Height, Spatial, Hybrid, Functional and Volumetric parameters are computed.



Since 2007, Sensofar has been member of the Technical Committee of the International organization for Standardization (ISO/TC213)

Guided system

SensoSCAN

Software drives the systems with its clear and intuitive user-friendly interface. The user is guided through the 3D environment, delivering a unique user experience.



Sample Navigation

An overview tool helps the user to inspect the sample during measurement preparation, check measurement positions before acquisition as well as assist in the automation procedure. Working with high magnification will be easier, as you will know where you are at every moment.



Auto 3D Function

Selecting 3D Auto function, the SensoSCAN software automatically determines the correct illumination and the appropriate measurement range, and then performs the chosen measurement type. A high-quality result can thus be obtained within just a few seconds.



Analysis & Reporting

It is also possible to create analysis templates to apply pre-determined filter and operator configurations to repeated measurements. And finally, obtain a clear and well-structured report for each measurement, showing the 3D data, a 2D profile and all the ISO parameters.

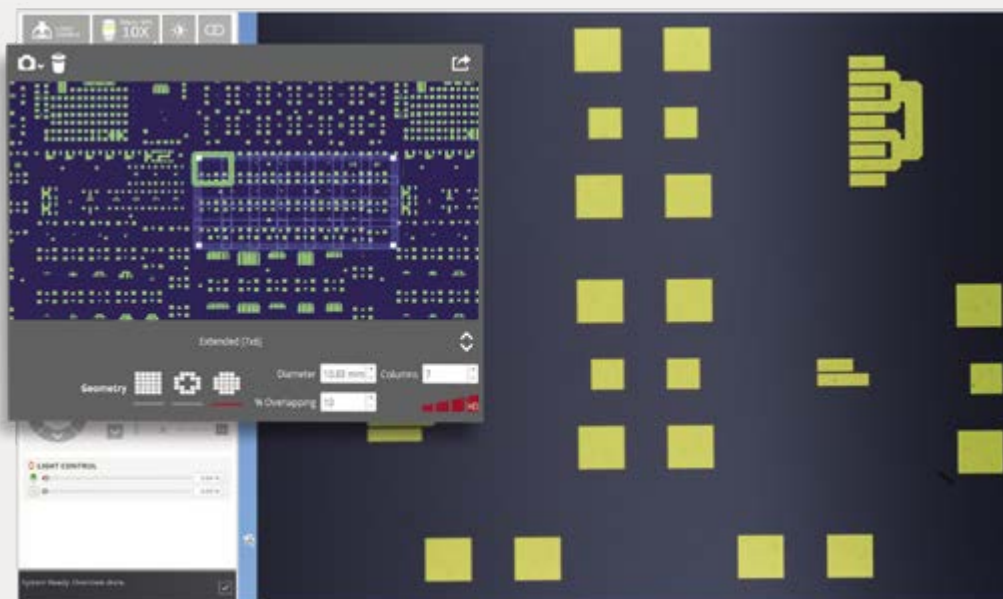

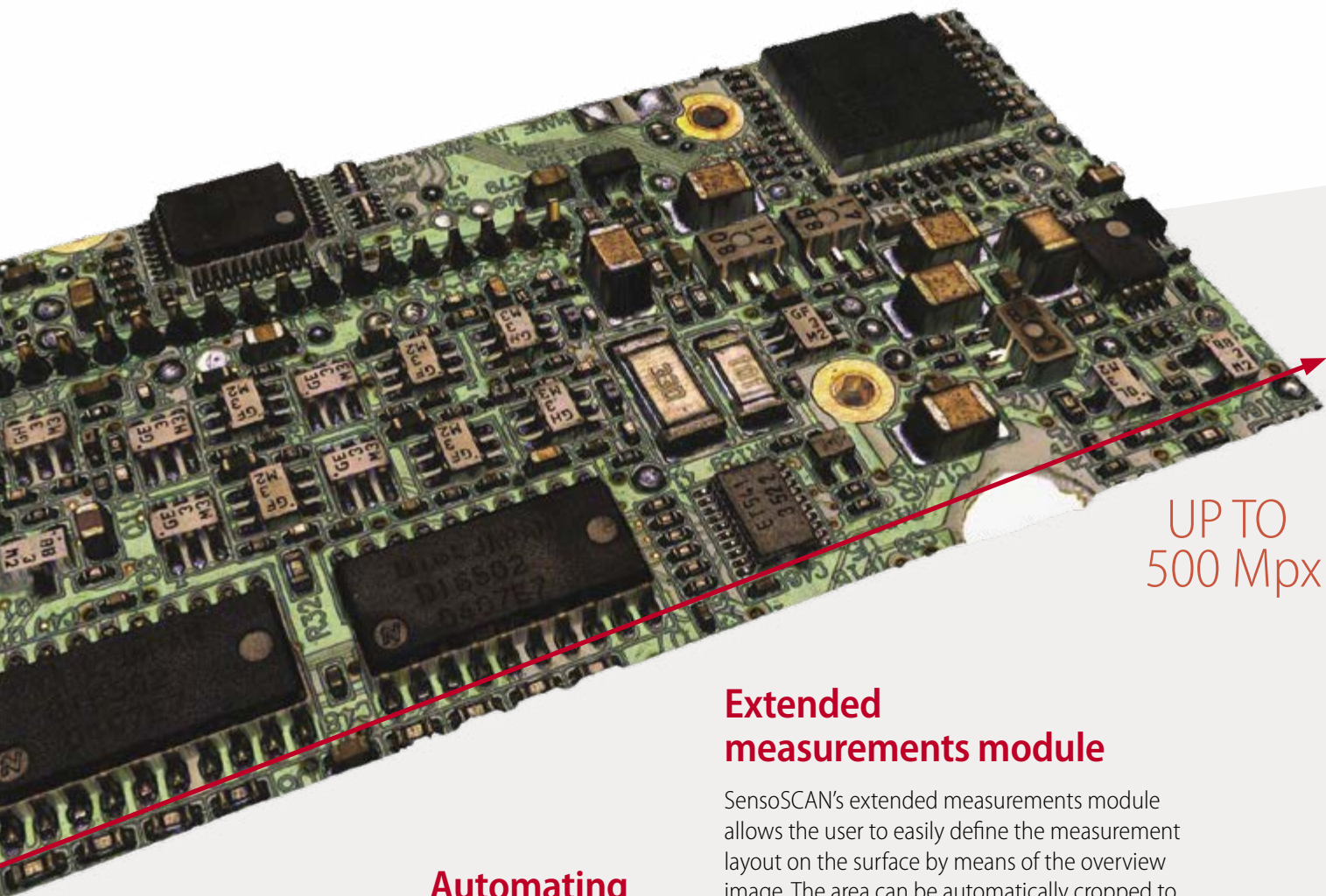

UP TO
500 Mpx

Automating procedures module

Automated measurements are obtained using the Recipes tool, an easily customizable tool for creating quality control procedures. It is ideal for Quality Control inspection, and it is extremely easy to define procedures for automating measurements with the profile manager tool, sample identification, data exportation and 'pass or fail' criteria.

Extended measurements module

SensoSCAN's extended measurements module allows the user to easily define the measurement layout on the surface by means of the overview image. The area can be automatically cropped to rectangular, circular or ring areas of interest. Wide areas up to 500 million pixels are possible. Several scanning strategies such as autofocusing on each field, or focus tracking to minimize vertical scanning range are available.

Multiple powerful acquisition settings

Numerous acquisition parameters can be adapted to best suit the intended measurement. For example, various autofocus settings help to reduce the acquisition time, HDR function helps to improve the illumination of complex 3D structures and selectable Z-scan options also provide an opportunity to optimize the acquisition for varying 3D surfaces.

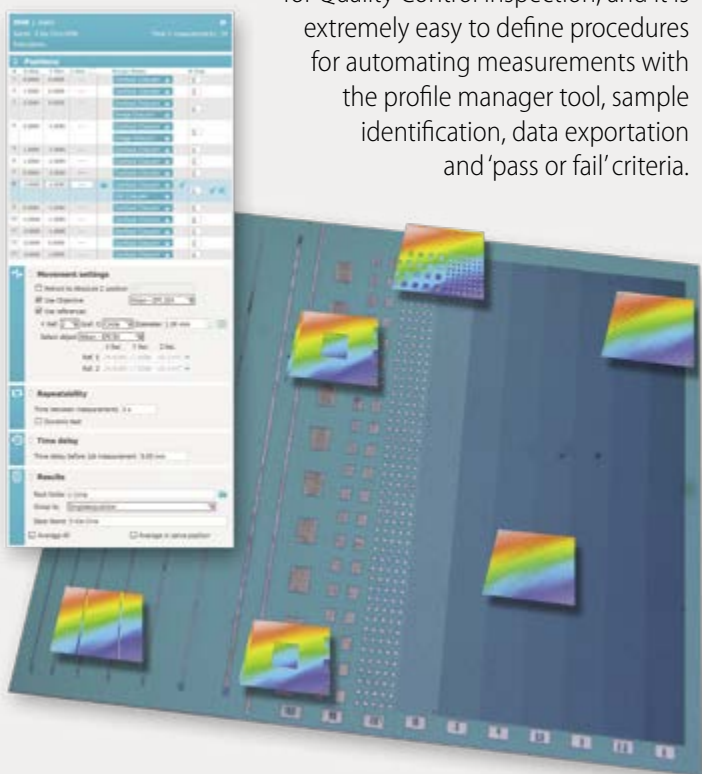

Powerful advanced analysis software

SensoVIEW



SensoVIEW is an ideal software for a broad range of analysis tasks. For applications requiring a more complete analysis suite, advanced software packages are optionally available – SensoMAP and SensoPRO.

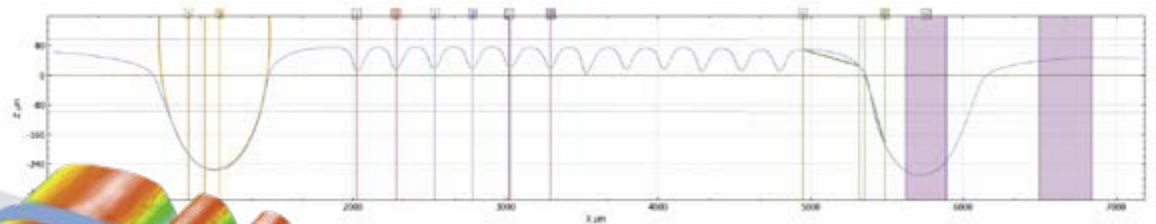
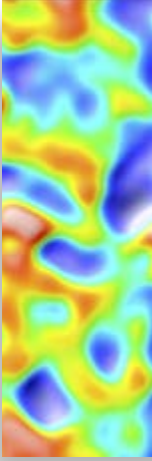

ANNOTATIONS		
1	Distance	$\Delta L = 257.35 \mu\text{m}$ $\Delta Z = 3.4741 \mu\text{m}$ $\angle = 0.77^\circ$
2	Distance	$\Delta L = 246.39 \mu\text{m}$ $\Delta Z = 1.0388 \mu\text{m}$ $\angle = 0.24^\circ$
3	Distance	$\Delta L = 267.67 \mu\text{m}$ $\Delta Z = 2.4124 \mu\text{m}$ $\angle = 0.52^\circ$
5	Circle	$\text{Dxy} = 726.04 \mu\text{m}$ $\text{Axy} = 414015.42 \mu\text{m}^2$
6	Angle	$\angle = 131.2431^\circ$
7	Distance	$\Delta L = 500.1 \mu\text{m}$ $\angle = 179.68^\circ$
8	Angle	$\angle = 90.0000^\circ$

Interactive analysis tools

3D and 2D interactive views provide multiple scaling, display and render options. A comprehensive suite of tools for preliminary examination and analysis of 3D or 2D measurements is provided. Critical dimensions, angles, distances, diameters can be measured and features highlighted with new annotation tools.

SensoPRO



It has never been so easy to perform fast quality control in a production line. Thanks to SensoPRO, the operator in the production line only needs to load the sample and follow guided instructions. Plug-in-based data analysis algorithms provide a high degree of flexibility. New modules can be easily customized to other industry needs.

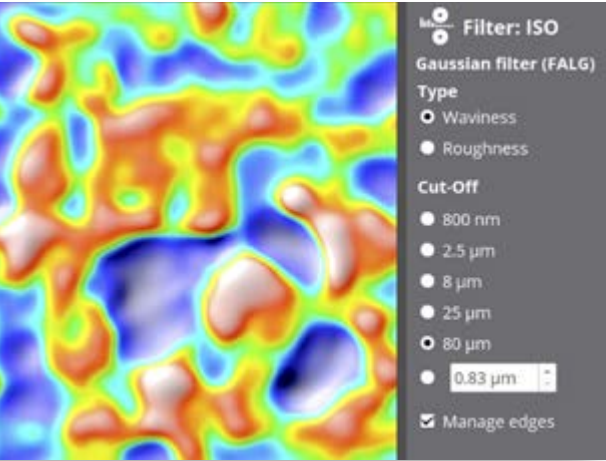

Sequential operators

A comprehensive set of operators provides the opportunity to retouch data points, restore non-measurable data, remove form (plane, sphere, polynomial), apply a range of filters and/or generate alternative layers by cropping, subtracting or extracting a profile. It is also possible to create analysis templates to apply pre-determined filter and operator configurations to repetitive measurements.

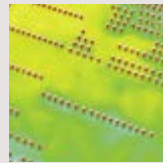

Bump

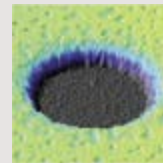

Hole

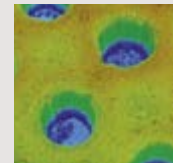

Dual Hole

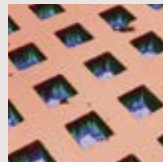

Rectangular Hole

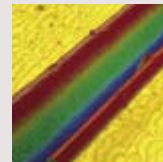

Laser Cut

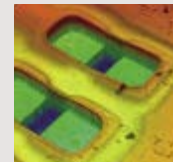

Pad



Spacer

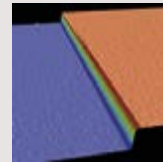

Step Height

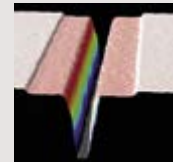

Double Step Height

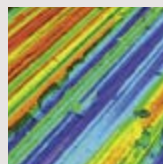

Surface Texture

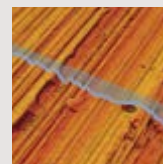

Surface Texture Profile

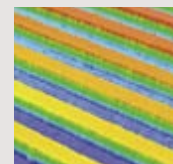

Trace

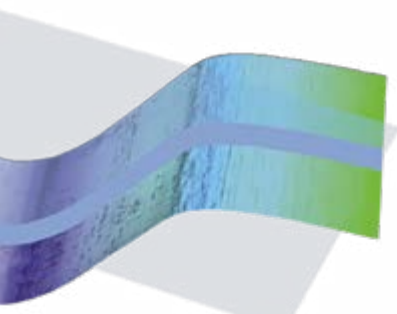

SensoMAP



SensoMAP, based on Mountains technology from Digital Surf, is an extremely powerful tool for analysis and reporting. SensoMAP software is completely modularly adaptable to customer requirements. Two levels (standard and premium) and several modules (2D, 3D or 4D modules, Advanced Contour, Grains & Particles, Statistics and Stitching) are available.

Why 3-in-1 tech

Confocal

Confocal profilers have been developed to measure the surface height of smooth to very rough surfaces. Confocal profiling provides the highest lateral resolution, up to 0.14 μm line & space, with spatial sampling can be reduced to 0.01 μm , which is ideal for critical dimension measurements. High NA (0.95) and magnification (150X) objectives are available to measure smooth surfaces with steep local slopes over 70° (for rough surfaces up to 86°). The proprietary confocal algorithms provide vertical repeatability on the nanometer scale.

Interferometry

PSI Phase Shift Interferometry has been developed to measure the surface height of very smooth and continuous surfaces with sub-Angstrom resolution, for all numerical apertures (NA). Very low magnifications (2.5X) can be employed to measure large fields of view with the same height resolution.

CSI Coherence Scanning Interferometry uses white light to scan the surface height of smooth to moderately rough surfaces, achieving 1 nm height resolution at magnification.

Ai Focus Variation^{NEW}

Active illumination Focus Variation is an optical technology that has been developed for measuring the shape of large rough surfaces. This technology is based on Sensofar's extensive expertise in the field of combined confocal and interferometric 3D measurements, and is specifically designed to complement confocal measurements at low magnification. It has been improved with the use of active illumination to get more reliable focus location even on optically smooth surface. Highlights of the technology include high slope surfaces (up to 86°), highest speeds (mm/s) and large vertical range measurements.

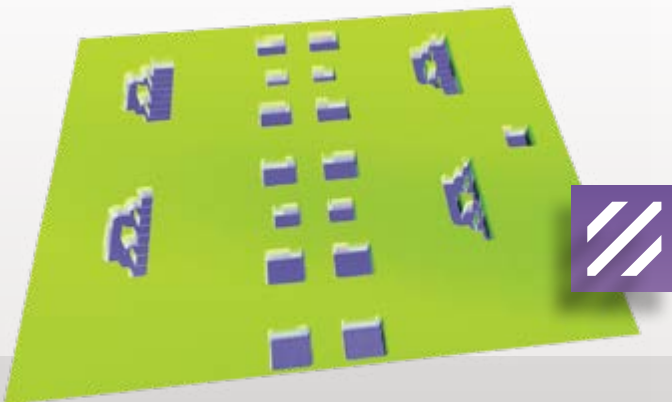

No moving parts

The confocal scanning technique implemented in Sensofar's systems is a Microdisplay Scan Confocal Microscope (ISO 25178-607). The microdisplay creates a rapidly switching device with no moving parts, making data acquisition fast, reliable and accurate. Due to this and the associated algorithms, Sensofar's confocal technique yields a class-leading vertical resolution, better than other confocal approaches and even better than laser scanning confocal systems.

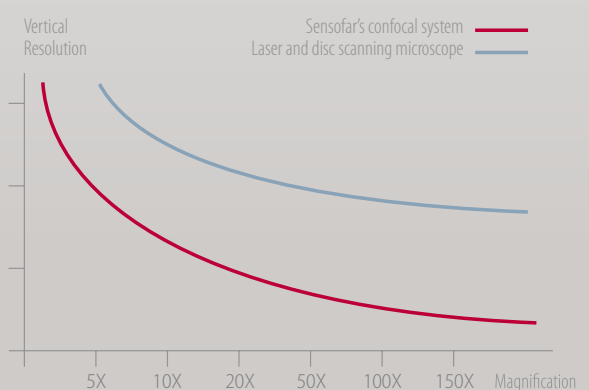

nologies?

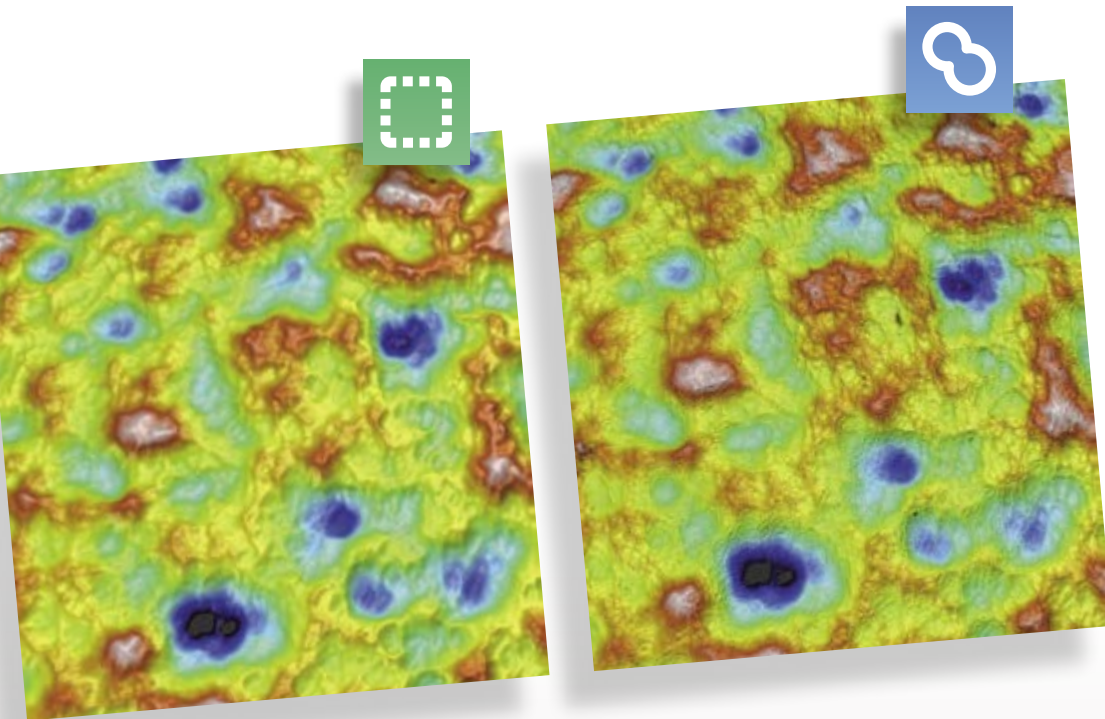

	Ai FOCUS VARIATION	CONFOCAL	INTERFEROMETRY

Rough samples	☆☆☆	☆☆☆	☆
Smooth samples	☆	☆☆	☆☆☆☆
Micro-scale features	☆☆	☆☆☆☆	☆☆☆☆
Nano-scale features		☆☆	☆☆☆☆
High local slopes	☆☆☆☆	☆☆	☆
Thickness		☆☆☆☆	☆☆☆☆

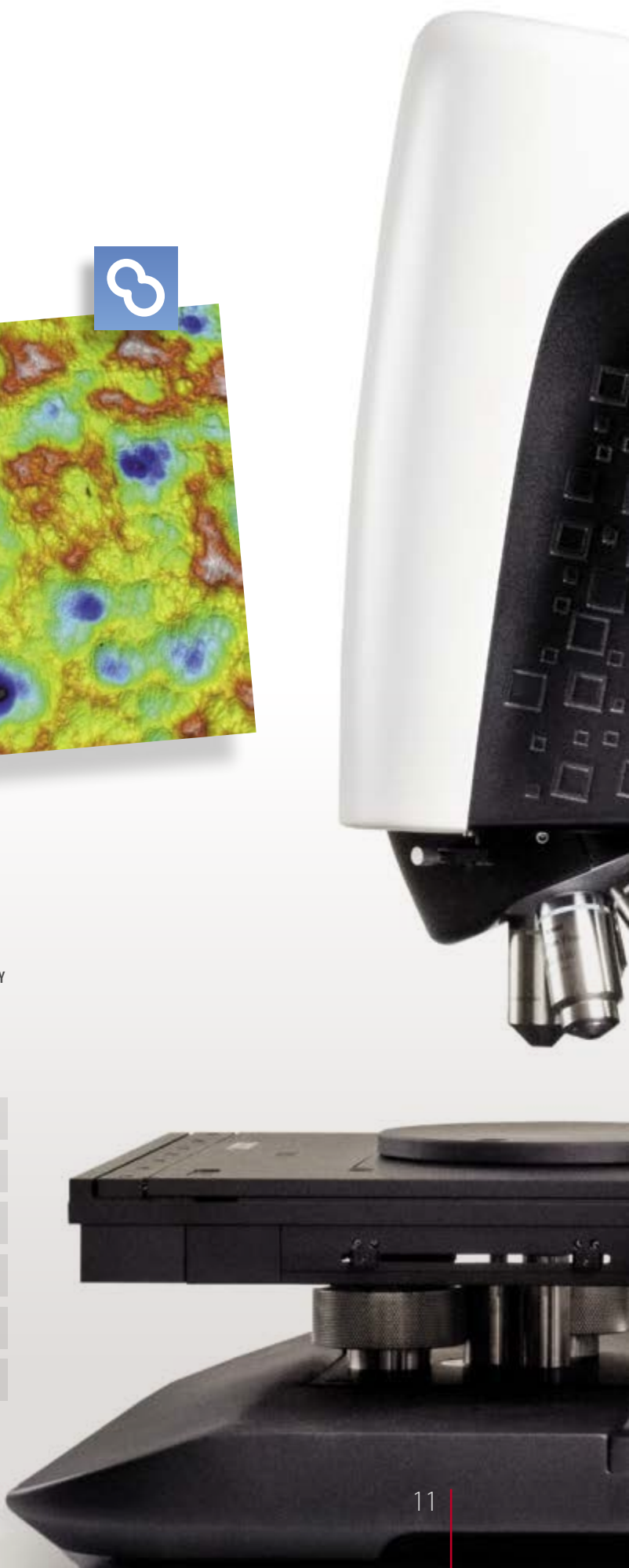

Features that ma

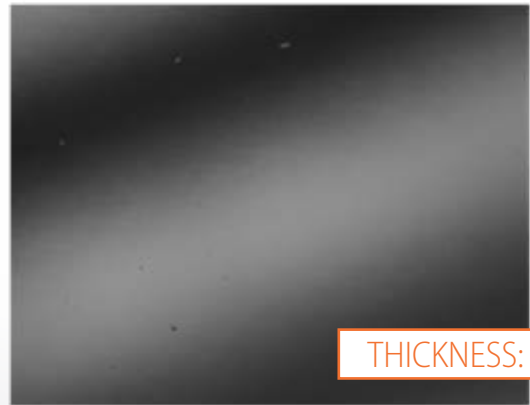

THICKNESS: 497nm

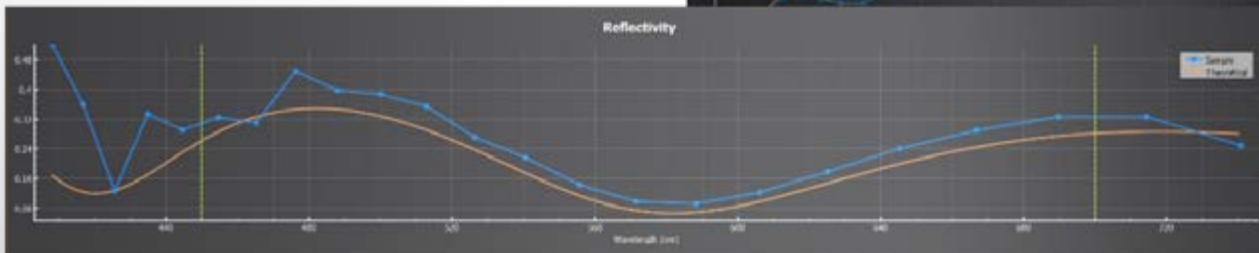
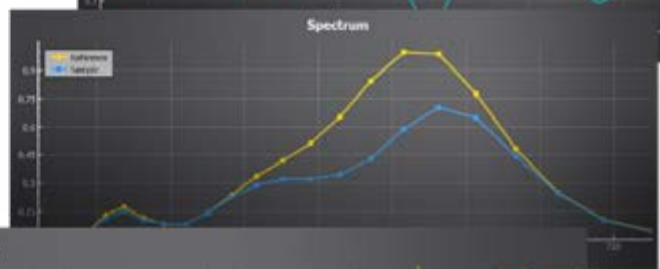
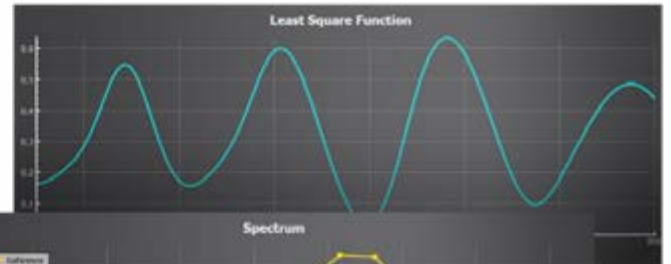

Thin film^{NEW}

Thin film measurement technique measures the thickness of optically transparent layers quickly, accurately, non-destructively and requires no sample preparation. The system acquires the reflectance spectrum of the sample in the visible range, and is compared with a simulated spectra calculated by the software, with layer thickness modification until the best fit is found. Transparent films from 50 nm to 1.5 μm can be measured in less than one second. Sample evaluation points are dependent on the objective magnification which can be as low as 0.5 μm and up to 40 μm .

ke the difference

Continuous Confocal

Revolutionary step in Confocal measurement technology, steadily reducing the acquisition time by a factor of 3. Continuous Confocal mode avoids the discrete (and time-consuming) plane-by-plane acquisition of classical Confocal by simultaneously scanning the in-plane and Z axis. Essential for reducing acquisition times for large area scans and large Z scans.

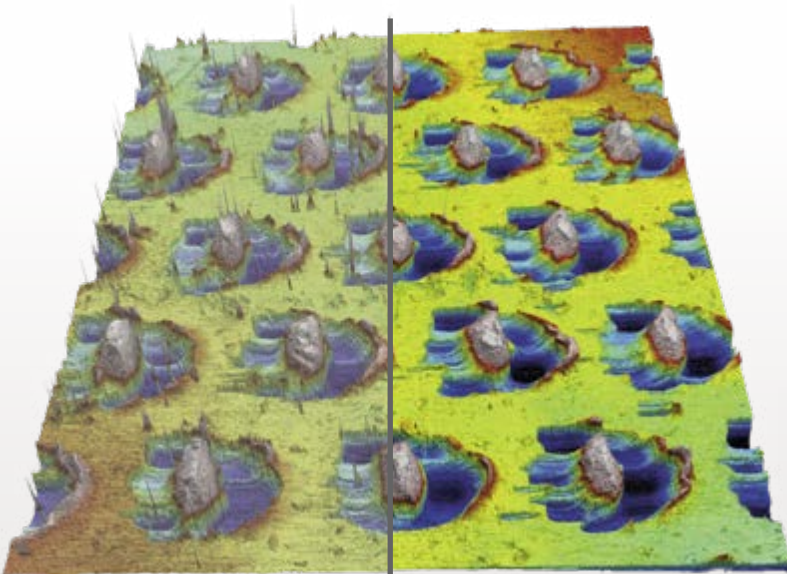
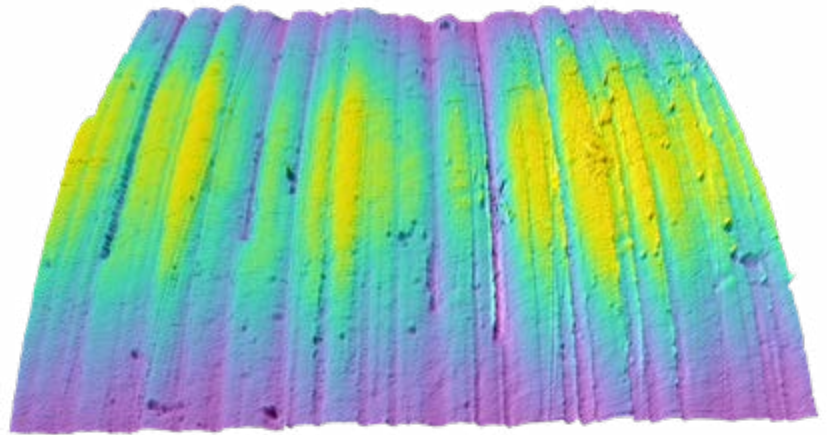

Applying SND

Smart noise detection

S neox uses a detection algorithm (SND) to detect those pixels where the data is not reliable. In comparison to other techniques that use spatial averaging, S neox does this process pixel by pixel without compromising lateral resolution loss.

HDR

High Dynamic Range mitigates reflection and drop-out points on highly reflective surfaces.

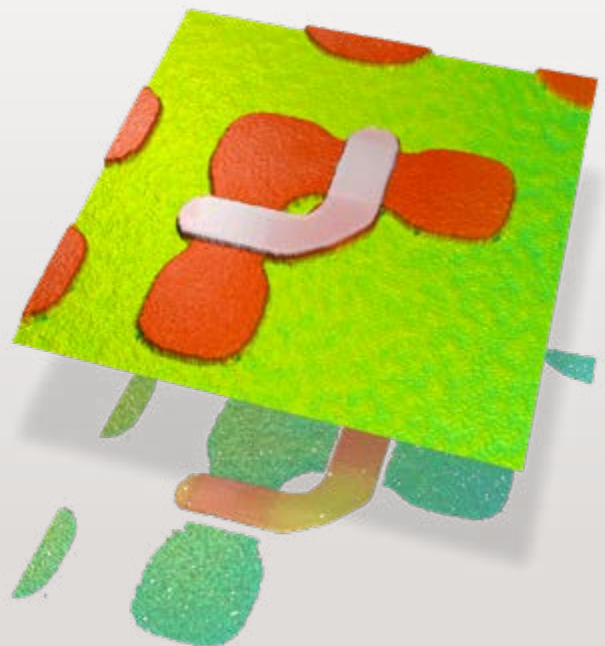

Outstanding lateral &

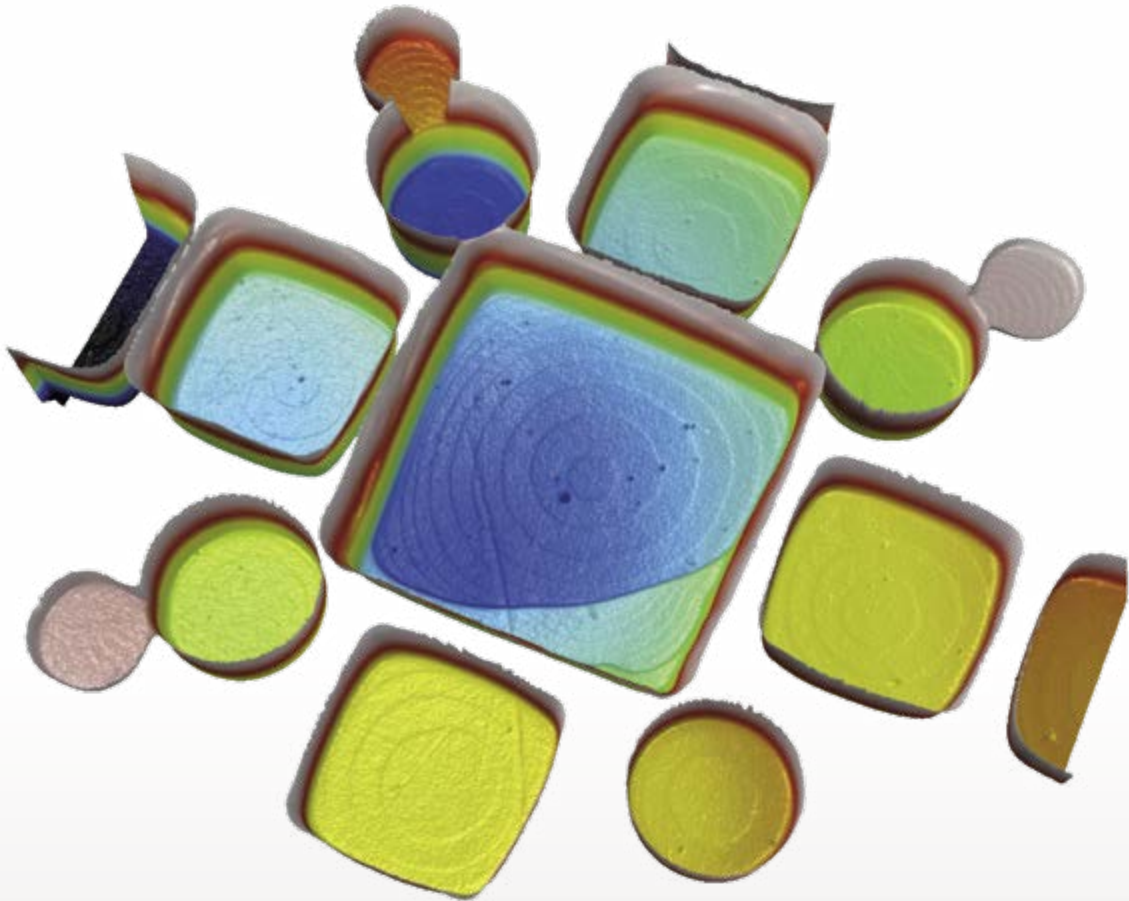

High resolution

Vertical resolution is limited by the instrument noise, which is fixed for Interferometry, but dependent of the numerical aperture for Confocal. Sensofar proprietary algorithms deliver nanometer level system noise for any measurements technique at the highest possible lateral resolution for an optical instrument. The topography shown is a sub-nanometer (0.3 nm) atomic layer. Courtesy of PTB.

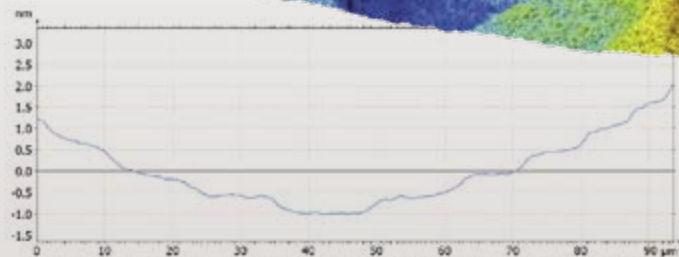
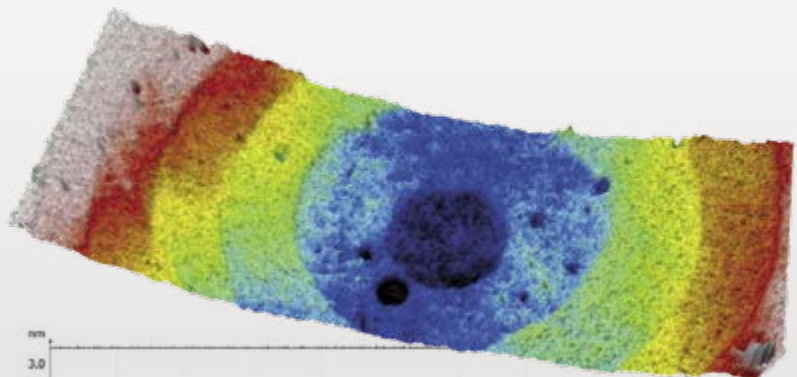

vertical resolution

DIC observation

Differential Interference Contrast (DIC) is used to emphasize very small height features that has no contrast in normal observation. With the use of a Nomarski prism, an interferential image is created resolving sub-nanometer scale structures not visible in brightfield or confocal images.

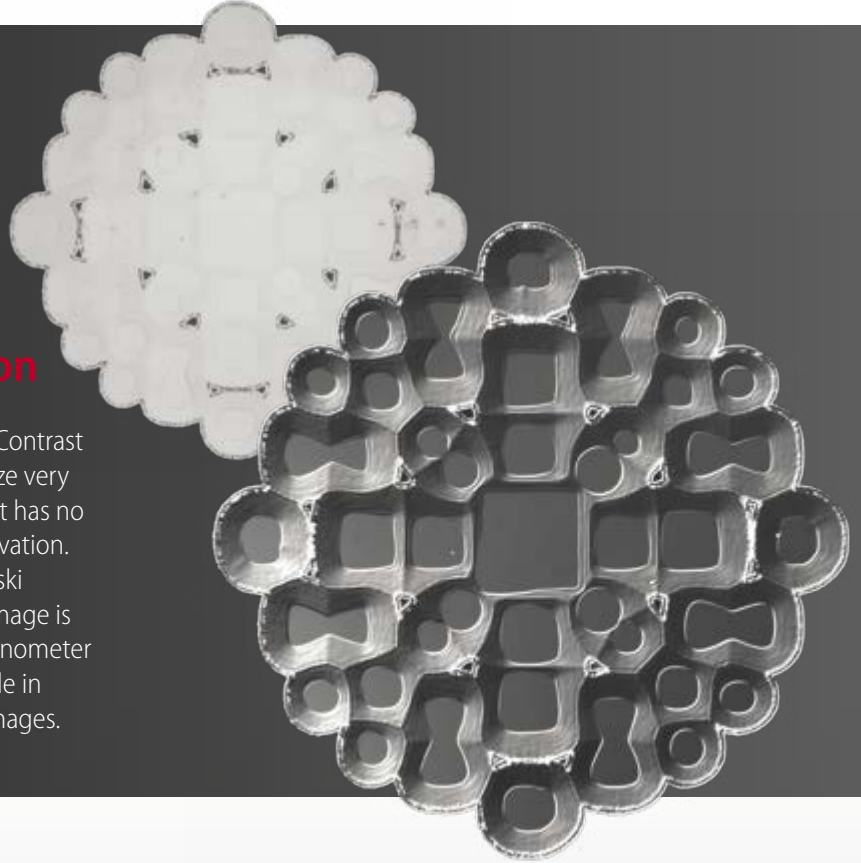

High slopes

Numerical Aperture (NA) of the microscope objective limits the maximum measurable slope on optically smooth surfaces, while optically rough, or scattering surfaces, provide signal beyond that limit. Sensofar algorithms are designed to measure up to 71° on smooth surfaces (0.95 NA), and up to 86° on rough samples.

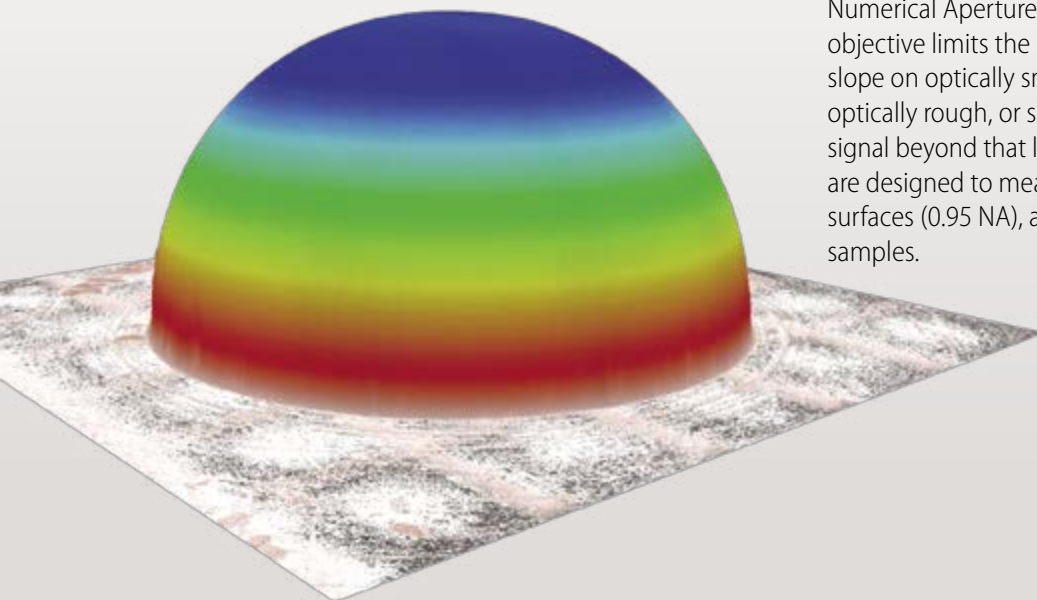

USER CASE STUDIES

“The new S neox is beautifully engineered to make it an outstanding instrument for measuring surface textures

It is amazingly fast and has excellent resolution. The flexibility and combination of Confocal, Interferometry, and Ai Focus Variation, along with excellent analysis options, make it a fantastic tool for a wide range of research and studies, covering many applications, topographies, and materials.”



Prof. Christopher A. Brown
Ph.D., PE, FASME
Director, Surface Metrology Lab
Department of Mech I Engineering
Worcester Polytechnic Institute, USA

MICROELECTRONICS

Measurements of the initial deflection of a nano pressure sensor for biological applications

In the fabrication of nano pressure sensors for biological applications, the sacrificial layer etching and the sealing of the two membranes separated by a vacuum gap is critical. Knowing the exact timing of the initial deflection of the membrane after the fabrication process is also key. As samples must be under vacuum pressure, measurements with a SEM may alter their initial state. That's why we chose Sensofar's S neox, since we were able to image and measure, in a quick non-destructive way, the deflection of the membranes after manufacturing.

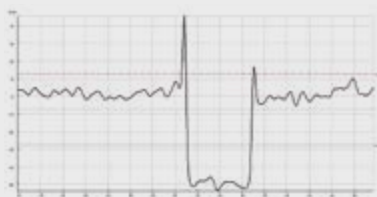
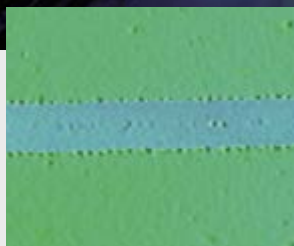
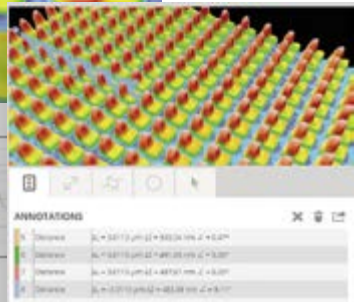
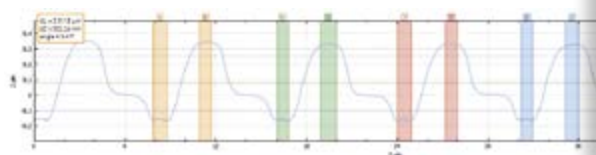
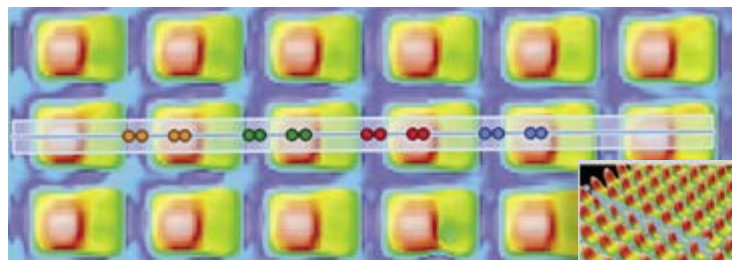
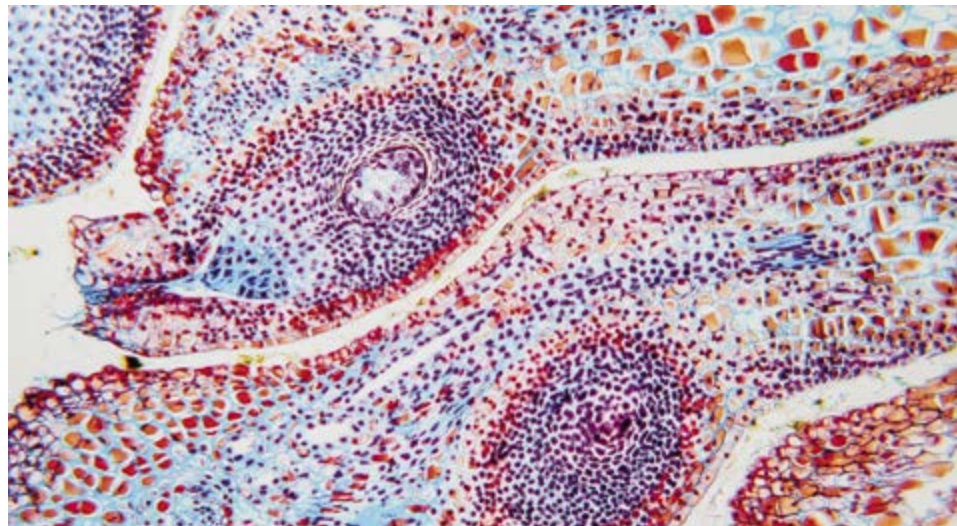

CONSUMER ELECTRONICS

Laser structuring of organic optoelectronic devices

To build large-scale organic light emitting diodes (OLEDs) for luminaires requires an invisible series of connections to reduce the device's current and then to mitigate ohmic losses. Laser-etched lines some with a width of a few micrometers and a depth of about 100 nm were monitored. The S neox allows us to detect if the removal process worked by measuring the thin film layers.



MICROMANUFACTURING

Measurements for femtosecond laser micro-milling and functional texturing

Sensofar's profiler has outstanding lateral resolution, which is a critical requirement for optimal texture functionality and ability to analyze nano structures over micro structures. With the S neox, we are able to obtain fast and non-destructive measurements to assure the micro-millings are delivered within the correct tolerance so that the functional texturing will work properly based on the created texture.

microrelleus

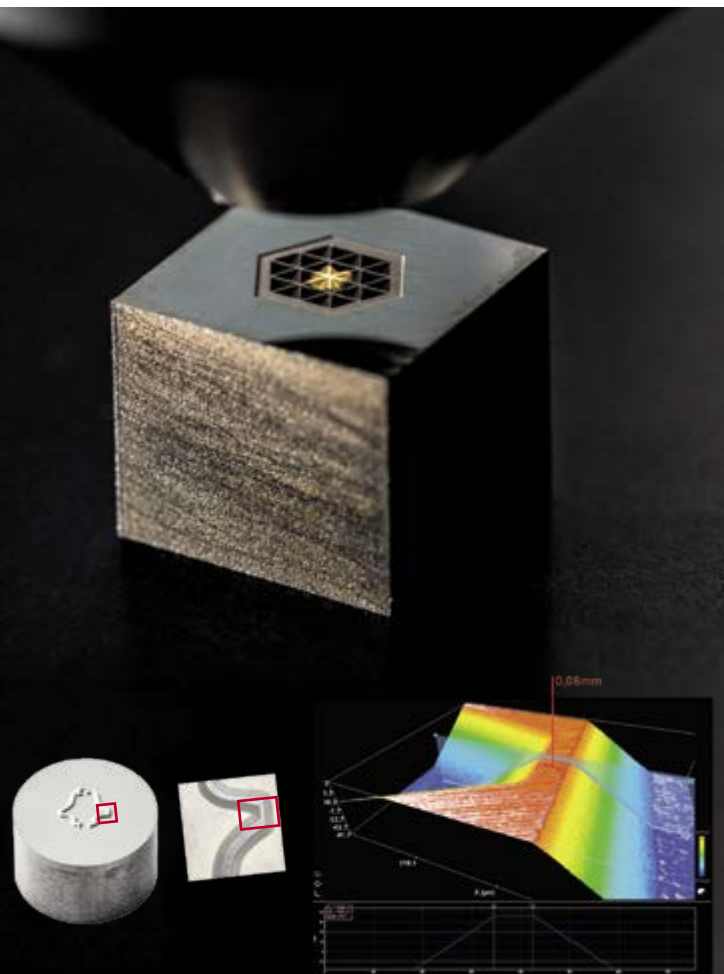

PALEONTOLOGY

The use of ochre 40,000 years ago in Africa

To analyze pieces of iron-rich mineral fragments and identify facets of ochre pieces ground on different rocks, the Confocal technology was an ideal technique. With the ability of the S neox to measure large areas and the set of filters to treat the 3D images, we are able to focus on the roughness and identify changes through time. It provides key information on the function it provided in those societies, and help establish when pigments were first used symbolically in the history of mankind.

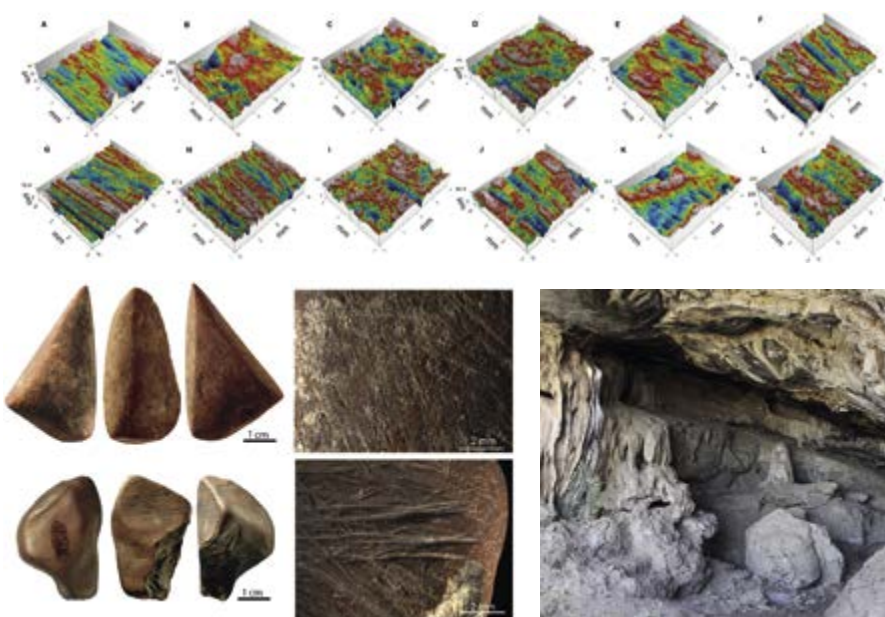

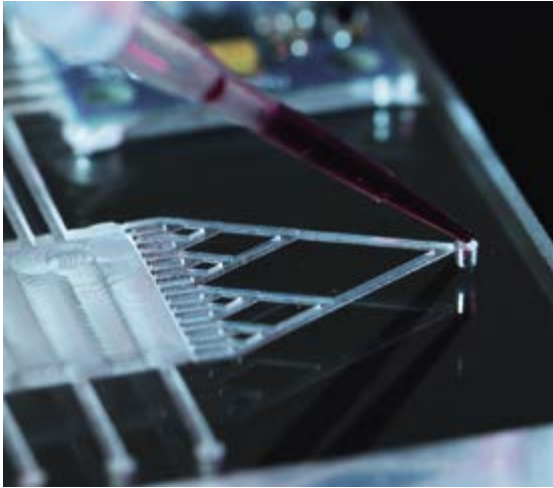

MEDICAL DEVICES

Characterization of microchannels manufactured with laser for microfluidic applications

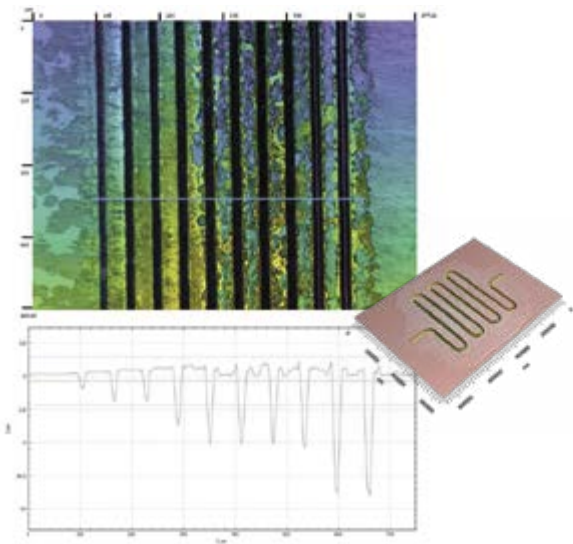

Microfluidic devices have different geometries which can be complex. One of the basic structures that comprise it, is the microchannel. Thanks to the S neox, we can easily characterize the roughness and the critical dimensions of the microchannels fabricated by laser technologies.



MEDICAL DEVICES

The effect of surgical insertion on dental implant surface topograph

Implant research has been focused on the development of new surface treatments to increase surface roughness, aiming to enhance the biological response and ultimately, the osteointegration. The study came to the conclusion that Sensofar's S neox's Confocal technology is an effective technique to characterize different locations on a complex threaded dental implant with high resolution.

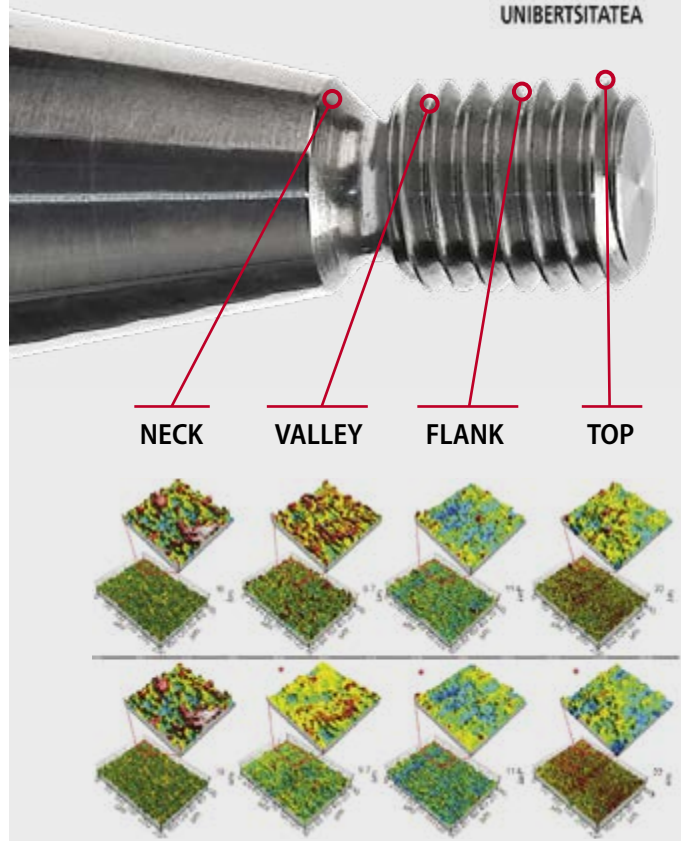

Hardware

Motorized nosepiece

The motorized nosepiece can hold up to six objectives simultaneously, including brightfield and interferometry objectives. The SensoSCAN software handles the motorized change automatically and corrects automatically any possible parfocality adjustment.



Stand structure

The S neox is a complete tool. Its design is ideal for obtaining a fast, non-invasive assessment of the micro- and nanogeometry of technical surfaces in multiple configurations. S neox provides the flexibility, durability and efficiency required from the standard setup for R&D and quality inspection laboratories to sophisticated, customized solutions for online process controls, measuring samples up to 300x300 mm² and maximum height up to 350 mm.



Ring light

The Ring light is based on an LED ring for illuminating samples in a uniform and efficient way. It is mounted above and around the objective, the ring light provides increased signal for the Ai Focus Variation technique. This ensures proper illumination at the focal plane.

Rotational stage

The Five Axis rotational stage consists of a high-precision motorized rotating A axis with 360° of endless rotation, 1 arc sec positioning repeatability, a motorized B axis, -30° to 110°, 1 arc min positioning repeatability, with limit switch. It is equipped with a System3R clamping system.

System configuration

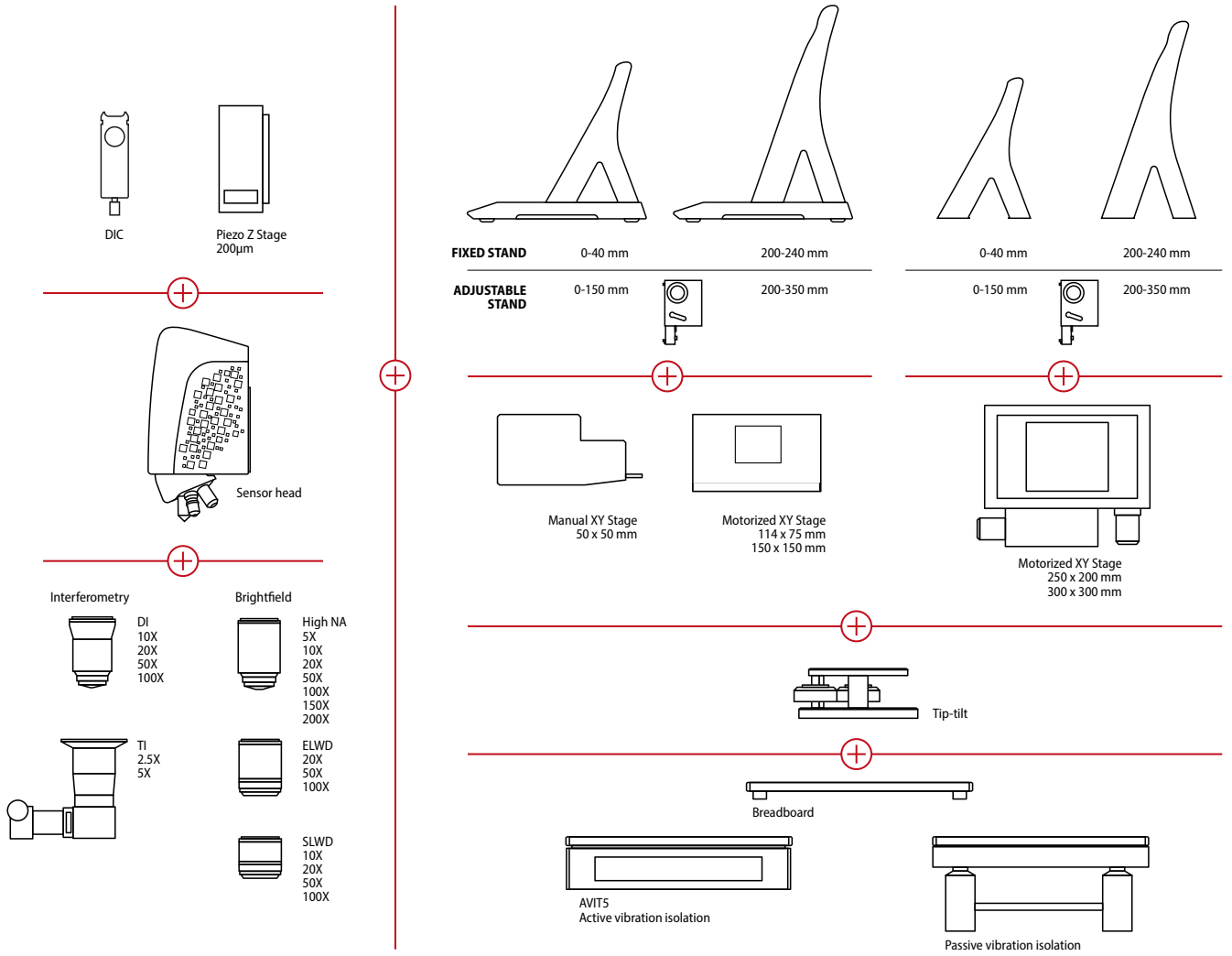

Dimensions

mm (inch)

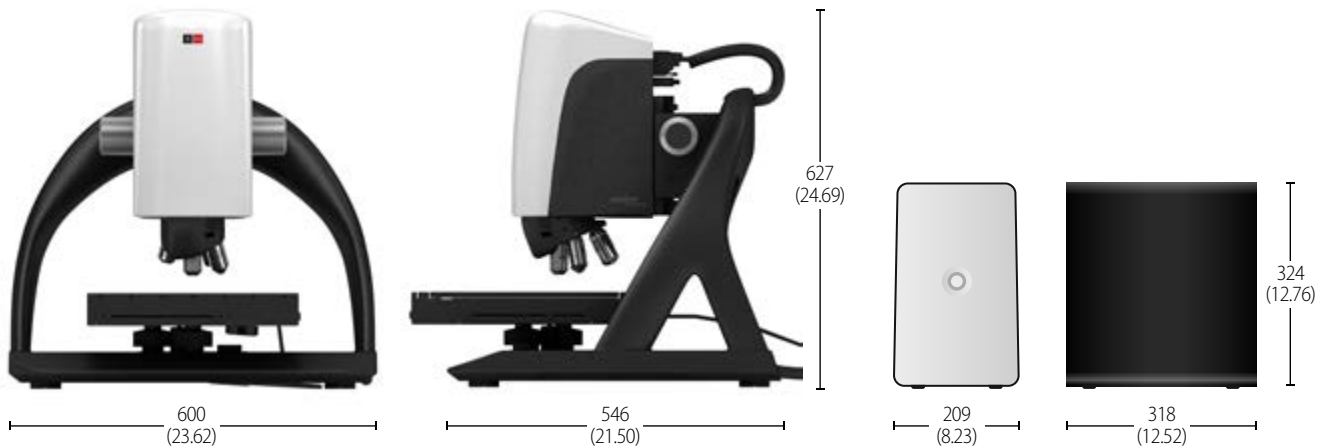

Objective lenses

	Brightfield						Interferometry					
MAG	5X	10X	20X	50X	100X	150X	2.5X	5X	10X	20X	50X	100X
NA	0.15	0.30	0.45	0.80	0.90	0.90	0.075	0.13	0.30	0.40	0.55	0.70
WD (mm)	23.5	17.5	4.5	1.0	1.0	1.5	10.3	9.3	7.4	4.7	3.4	2.0
FOV ¹ (µm)	3380x2820	1690x1410	840x700	340x280	170x140	110x90	6750x5640	3380x2820	1690x1410	840x700	340x280	170x140
Spatial sampling ² (µm)	1.38	0.69	0.34	0.13	0.07	0.05	2.76	1.38	0.69	0.34	0.13	0.07
Optical resolution ³ (µm)	0.93	0.46	0.31	0.17	0.15	0.15	1.87	1.08	0.46	0.35	0.25	0.20

	Confocal / Ai Focus Variation						PSI / ePSI / CSI					
System noise ⁴ (nm)	100	25	6	3	2	1	PSI/ePSI 0.1 nm (0.01 nm with PZT)			CSI 1 nm		
Maximum slope ⁵ (°)	9	17	26	53	65	65	4	8	17	23	33	44

System specifications

Measuring principle	Confocal, PSI, ePSI, CSI, Ai Focus Variation and Thin Film
Observation types	Brightfield, DIC, Sequential Color RGB, Confocal, Interferential Phase Contrast
Measurement types	Image, 3D, 3D thickness, profile and coordinates
Camera	5Mpx: 2442x2048 pixels (60 fps)
Total magnification (27" screen)	60X - 21600X
Display resolution	0.001 nm
Field of view	from 0.018 to 6.7 mm (single shot)
Max. Extended measuring area	10x12 (Max. Resolution); 175x175 (Low resolution) (500 Mpx)
Confocal frame rate	20 fps (5Mpx); 60 fps (1.2 Mpx)
Vertical scan range coarse	Linear stage: 40 mm range; 5 nm resolution
Vertical scan range fine	Piezoelectric scanner with capacitive sensor: 200 µm range; 0.5 nm resolution
Max. Z measuring range	PSI 20 µm; CSI 10 mm; Confocal & Ai Focus Variation 34 mm
XY stage range	Manual: 50x50 mm; Motorized: 100x72 mm, 150x150 mm, 250x200 mm, 300x300 mm
LED light sources	Red (630 nm); green (530 nm); blue (460 nm) and white (575 nm; center)
Ring light illumination	Green ring light compatible with 6 position nosepiece
Nosepiece	6 position fully motorized
Sample reflectivity	0.05 % to 100%
Sample weight	up to 25 Kg
Sample height	40 mm (standard); 150 mm and 350 mm (optional)
User Management rights	Administrator, supervisor, advanced operator, operator
Advanced Software Analysis	SensoMAP, SensoPRO, SensoMATCH, SensoCOMP (optional)
Power	Line Voltage 100-240 V AC; frequency 50/60 Hz single phase
Computer	Latest INTEL processor; 3840x2160 pixels resolution (4K) (27")
Operating system	Microsoft Windows 10, 64 bit
Weight	52 Kg (110 lbs)
Environment	Temperature 10 °C to 35 °C; Humidity <80 % RH; Altitude <2000 m

Accuracy and repeatability⁶

	Standard	Value	U, σ	Technique
Step height		48600 nm	U=300 nm, σ= 10 nm	Confocal & CSI
		7616 nm	U=79 nm, σ= 5 nm	Confocal & CSI
		941.6 nm	U=7 nm, σ= 1 nm	Confocal & CSI
		186 nm	U=4 nm, σ= 0.4 nm	Confocal & CSI
Areal roughness (Sa) ⁷		44.3 nm	U=0.5 nm, σ= 0.1 nm	PSI
		10.8 nm	U=0.5 nm, σ= 0.05 nm	PSI
		0.79 µm	U=0.04 µm, σ=0.0005 µm	Confocal, AiFV & CSI
	Profile roughness (Ra) ⁸	2.40 µm	U=0.03 µm, σ= 0.002 µm	Confocal, AiFV & CSI
		0.88 µm	U=0.015 µm, σ= 0.0005 µm	Confocal, AiFV & CSI
		0.23 µm	U=0.005 µm, σ= 0.0002 µm	Confocal, AiFV & CSI

1 Maximum field of view with 3/2" camera and 0.5X optics. **2** Pixel size on the surface. **3** L&S: Line and Space. Values for blue LED. **4** System noise measured as the difference between two consecutive measures on a calibration mirror placed perpendicular to the optical axis. For interferometry objectives, PSI, 10 phase averages with vibration isolation activated. The 0.01 nm are achieved with Piezo stage scanner and temperature controlled room. Values for green LED (white LED for CSI). Resolution HD. **5** On smooth surfaces, up to 71°. On scattering surfaces, up to 86°. **6** Objective used for Confocal and Ai Focus Variation 50X 0.80 NA and for CSI and PSI 50X 0.55NA. Resolution 1220x1024 pixels. All measurements are done using PZT. Uncertainty (U) according to ISO/IEC guide 98-3:2008 GUM:1995, K=1,96 (level of confidence 95%). σ according to 25 measures. **7** Area of 1x1 mm. **8** Profile of 4 mm length.



SENSOFAR is a leading-edge technology company that has the highest quality standards within the field of surface metrology

Sensofar Metrology provides high-accuracy optical profilers based on confocal, interferometry and focus variation techniques, from standard setups for R&D and quality inspection laboratories to complete non-contact metrology solutions for in-line production processes. The Sensofar Group has its headquarters in Barcelona, also known as a technology and innovation hub in Europe. The Group is represented in over 30 countries through a global network of partners and has its own offices in Asia, Germany and the United States.

HEADQUARTERS

SENSOFAR METROLOGY | BARCELONA (Spain) | T. +34 93 700 14 92 | info@sensofar.com

SALES OFFICES

SENSOFAR ASIA | SHANGHAI (China) | T. +86 021 51602735 | info.asia@sensofar.com

SENSOFAR GERMANY | MUNICH (Germany) | T. +49 151 14304168 | info.germany@sensofar.com

SENSOFAR USA | NEWINGTON (USA) | T. +1 617 678 4185 | info.usa@sensofar.com

sensofar.com

